

Window/Wall Mounting Kit

Available now, the Ubiquiti Networks Window/Wall Mounting kit for NanoStation. Vertically and horizontally adjustable. MSRP at \$20 (\$18 for 100 pc quantity)

For more information: www.ubnt.com

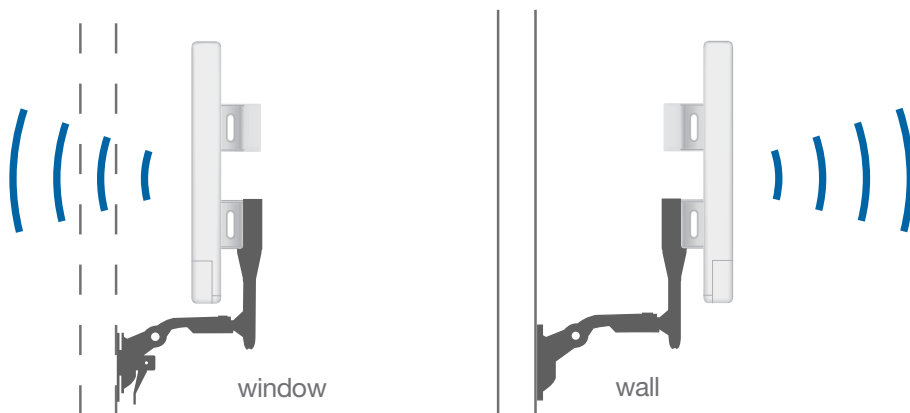

The kit comes with interchangeable mounting adapters (suction mount for window, wall screws for wall) so the NanoStation can be easily fitted on a window or wall.

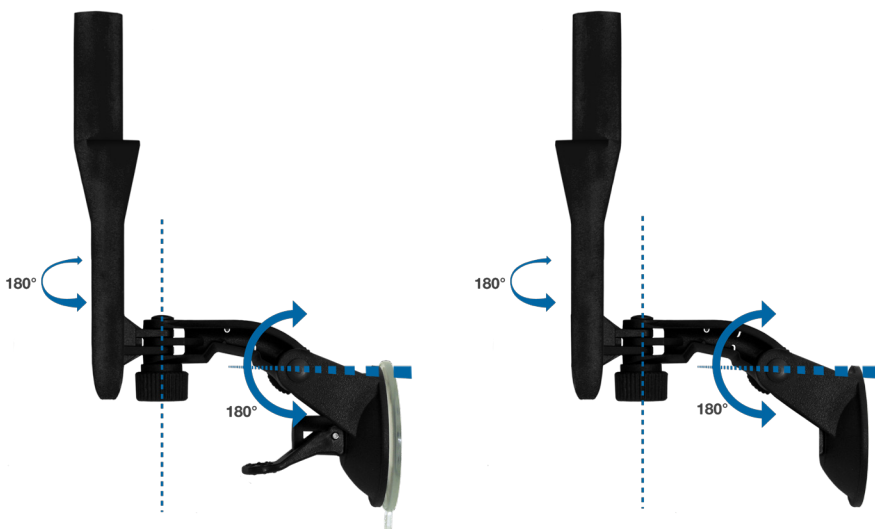

Two adjustable points that makes the mount extremely versatile in adjusting NanoStation to the exact position you want.



Mount with window mount adapter attached to NanoStation.

Installation Instructions

The NanoStation Window/Wall Mounting kit comes with everything necessary for installation (all you need is a screwdriver). The Kit can easily be installed by following just three steps.

Wall

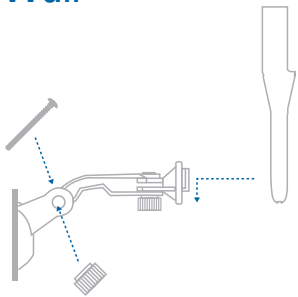

1. Assemble Mount

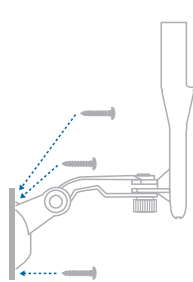

2. Secure on wall

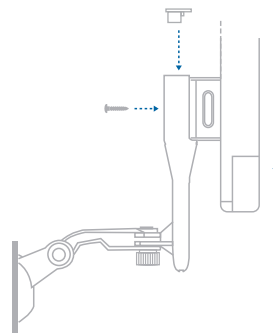

3. Secure Device on Mount

Window

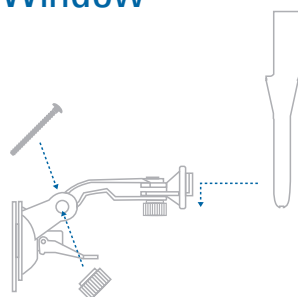

1. Assemble Mount

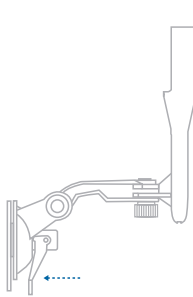

2. Secure on window

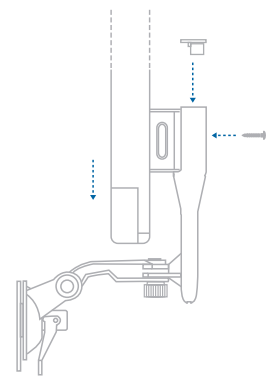

3. Secure Device on Mount

Kit Contents



Wall Screws



Holster Screw



Window Adapter



Wall Adapter



Arm



Holster