



5G Dongle

UF31

User Guide



Safety Precautions

Milesight will not shoulder responsibility for any loss or damage resulting from not following the instructions of this operating guide.

- ❖ The device must not be disassembled or remodeled in any way.
- ❖ To avoid risk of fire and electric shock, do keep the product away from rain and moisture before installation.
- ❖ Do not place the device where the temperature or humidity is below/above the operating range.
- ❖ The device must never be subjected to drops, shocks or impacts.
- ❖ Make sure the device is firmly fixed when installing.
- ❖ Make sure the plug is firmly inserted into the power socket.
- ❖ Do not pull the antenna or power supply cable, detach them by holding the connectors.

© 2011-2022 Xiamen Milesight IoT Co., Ltd. All rights reserved.

All information in this user guide is protected by copyright law. Whereby, no organization or individual shall copy or reproduce the whole or part of this user guide by any means without written authorization from Xiamen Milesight IoT Co., Ltd.

Declaration of Conformity

UF31 is in conformity with the essential requirements and other relevant provisions of RoHS.

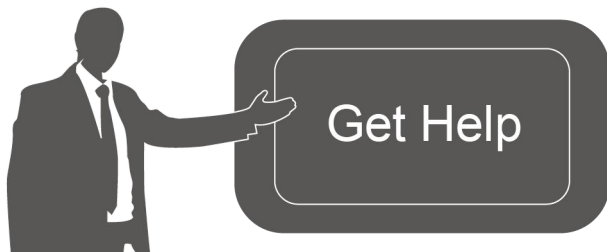

For assistance, please contact
Milesight technical support:
Email: iot.support@milesight.com
Tel: 86-592-5085280
Fax: 86-592-5023065
Address: Building C09, Software Park III,
Xiamen 361024, China

Revision History

Date	Doc Version	Description
May 11, 2022	V 1.0	Initial version

Contents

1. Product Introduction	5
1.1 Overview	5
1.2 Key Features	5
2. Hardware Introduction	5
2.1 Packing List	5
2.2 Hardware Overview	6
2.3 LED Indicators	6
2.4 Dimensions	7
2.5 Reset Button	7
3. Hardware Installation	7
3.1 SIM Installation	7
3.2 Antenna Installation	8
3.3 Device Installation	8
3.3.1 Wall Mounting	8
3.3.2 DIN Rail Mounting	9
3.4 Protective Grounding Installation	9
4. Access to Web GUI	10
5. Web Configuration	12
5.1 Status	12
5.1.1 Overview	12
5.1.2 Cellular	13
5.1.3 Routes	15
5.2 Network	16
5.2.1 Interfaces	16
5.2.1.1 Cellular	16
5.2.1.2 LAN	18
5.2.1.3 Global network options	21
5.2.2 Device Management	21
5.2.3 Diagnostics	22
5.3 System	22
5.3.1 System	23
5.3.1.1 General Settings	23
5.3.1.2 Time Synchronization	23
5.3.2 Administration	23
5.3.2.1 Router Password	23
5.3.2.2 SSH Access	24
5.3.2.3 SSH-Keys	24
5.3.3 Backup / Flash Firmware	25
5.3.4 Reboot	26
5.3.5 Log Control	26
5.3.5.1 General Settings	26
5.3.5.2 Advanced Settings	27

- 5.3.6 Cellular Debugger 27
- 6. Application Examples 29
 - 6.1 Cellular Connection 29
 - 6.2 Firmware Upgrade 31
 - 6.3 Restore Factory Defaults 32

1. Product Introduction

1.1 Overview

Milesight UF31 5G Dongle is designed as an easy-to-use solution providing for 5G wireless networking application. It supports 5G NSA & SA, 4G LTE and 3G networks from telecom service providers of most countries in the world. The USB type-C port and Ethernet port are adopted to provide high-speed internet access for field devices.

With a compact size and industrial design, UF31 is easy to carry out or embed to any equipment, which is particularly suitable for smart offices, video surveillance, digital media implementations, industrial automation, traffic applications, robots and so on.

1.2 Key Features

- Support global 5G NSA&SA/4G LTE/WCDMA network, enables up to 4.13 Gbps download speeds
- Plug and play, provide lightning transmission via Gigabit Ethernet port or USB 3.0
- Embeds hardware watchdog to automatically recover from various failure, ensure highest level of availability
- Wide operating temperature range from -20°C to 50°C and industrial design for harsh environment
- USB or DC power supply optional
- Easy to deploy anywhere with compact size, suit for embedded installation
- Iptables firewall and VPN tunnels to ensure security data transmission
- WEB GUI and CLI enable the admin to achieve simple management and quick configuration among a large quantity of devices
- DeviceHub provides remote monitoring, bulk configuration, and centralized management

2. Hardware Introduction

2.1 Packing List

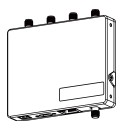

1 ×

UF31 Device

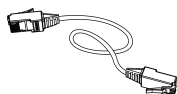

1 ×

Ethernet Cable

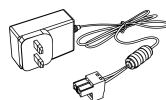

1 ×

Power Adapter

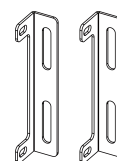

2 ×

Mounting Ear Kits



4 × Wall Mounting Kits

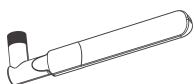

4 × Stubby Cellular Antennas

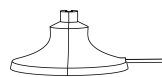

4 × Antenna Magnetic Mounts

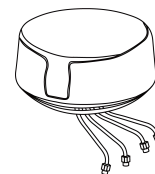

1 × 5G Antenna Box (Optional)

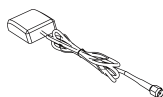

1 × GPS Antenna (Optional)

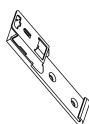

1 × DIN Rail Clip (Optional)



1 × Quick Guide



1 × Warranty Card



1 × USB 3.0 Cable (Customizable)

! If any of the above items is missing or damaged, please contact your sales representative.

2.2 Hardware Overview

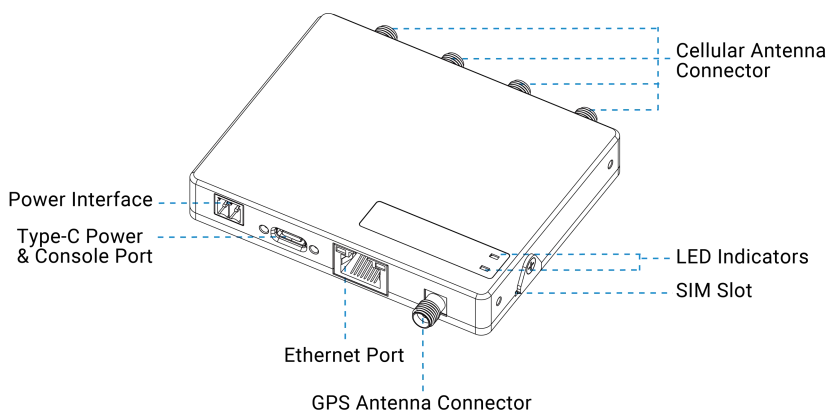

2.3 LED Indicators

LED	Indication	Status	Description
STATUS	Power & System Status	Off	The power is switched off
		Orange	Static: The system is startup
		Green	Static: The system is running properly

		Red	Static: The system goes wrong
5G	Cellular Status	Off	SIM card is registering or fails to register (or there are no SIM cards inserted)
		Green	Blinking rapidly: SIM card has been registered and is dialing up now
			Static: SIM card has been registered and dialed up to 5G network
		Orange	Static: SIM card has been registered and dialed up to 4G network
Ethernet Port	Link Indicator (Orange)	Off	Disconnected or connect failure
		On	Connected
		Blinking	Transmitting data
	Rate Indicator (Green)	Off	100 Mbps mode
		On	1000 Mbps mode

2.4 Dimensions (mm)

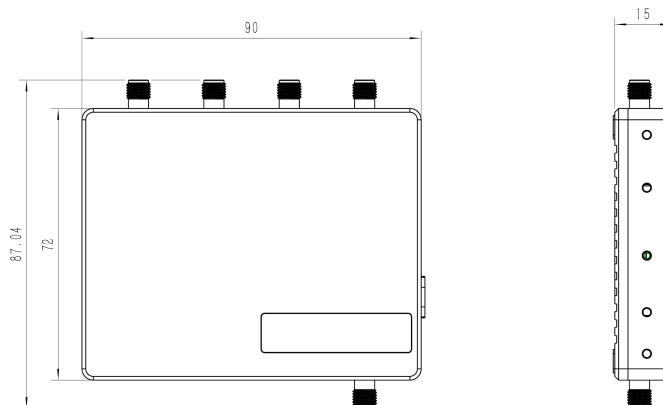

2.5 Reset Button

The reset button is inside the device.

Function	Description	
	STATUS & 5G LED	Action
Reset	Static	Press and hold the reset button for more than 5 seconds.
	Static → Blinking	Release the button and wait.
	Off → Static Green	The device resets to factory default.

3. Hardware Installation

3.1 SIM Installation

Remove the sheet on the SIM slot, insert the SIM card into the slot according to the direction icon on the device, then fix the sheet on the slot with screw.

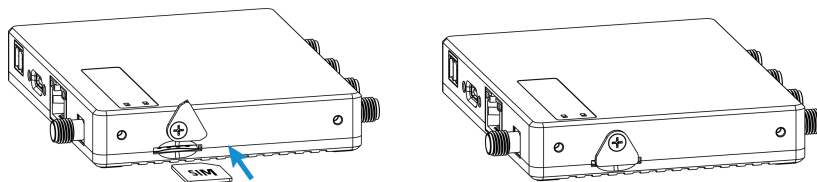

3.2 Antenna Installation

Rotate the antenna into the antenna connector accordingly. Antennas should be installed vertically always on a site with a good signal.

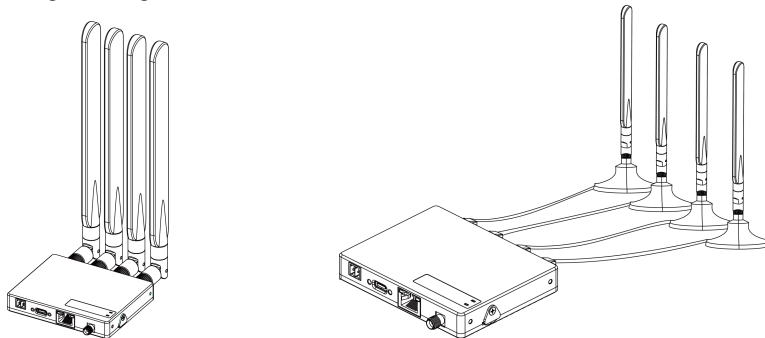

If an antenna box is being used, the installation position should be drilled a hole to fix the antenna box.

- Recommended hole size: $\phi 28.0 \pm 0.5$ mm
- Recommended thickness size: 3.0 ± 1.0 mm

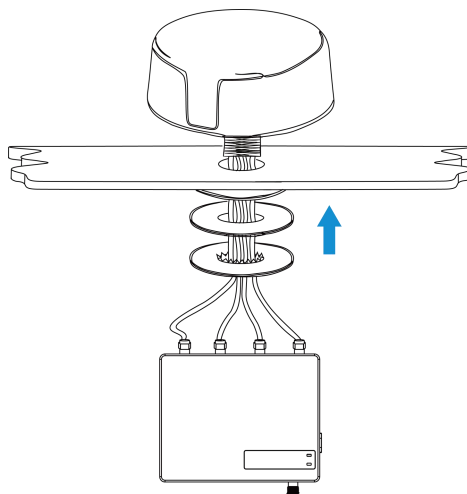

3.3 Device Installation

UF31 device can be placed on a desktop or mounted to a wall or a DIN rail.

3.3.1 Wall Mounting

1. Fix the two mounting ears to both side of the device with screws.

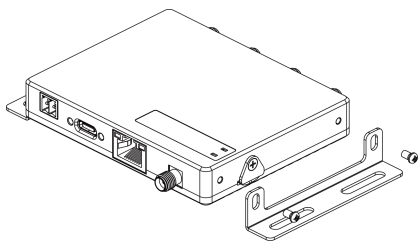

2. Drill 4 holes on the wall according to the mounting ear's hole and fix the wall plugs into the wall holes, then fix the device to the wall plugs with mounting screws. When installation, it's suggested to fix the two screws on the top at first.

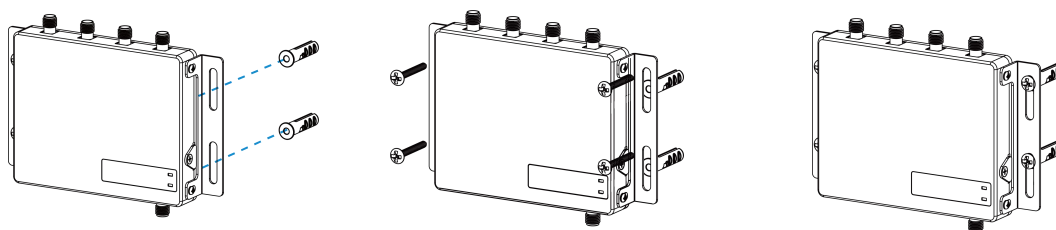

3.3.2 DIN Rail Mounting

1. Fix the mounting clip to the device with 3 screws.

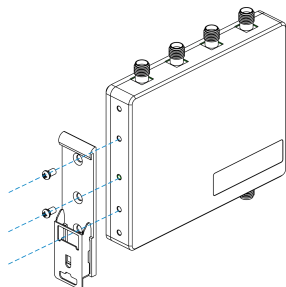

2. Hang the device to the DIN rail. The width of DIN rail is 3.5 cm.

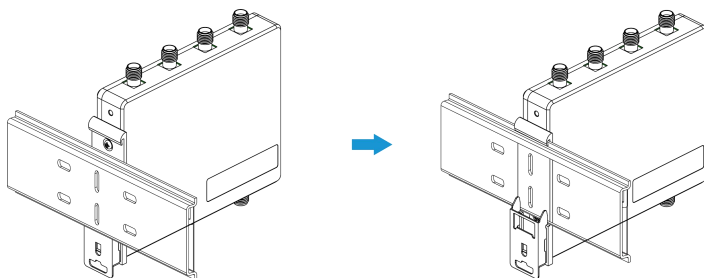

3.4 Protective Grounding Installation

Connect the grounding ring of the cabinet's grounding wire onto the grounding stud and screw up the grounding nut.

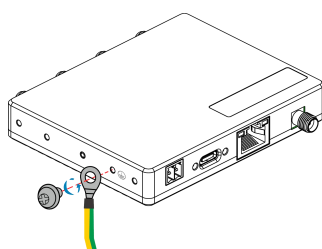

4. Access to Web GUI

UF31 provides user-friendly web GUI for configuration and users can access it via LAN port or USB. This chapter explains how to access to Web GUI of the UF31 device.

Username: **admin**

Password: **password**

Connect PC to the LAN port or USB port directly to access the web GUI of device. The following steps are based on Windows 10 operating system for your reference.

1. Go to “Control Panel” → “Network and Internet” → “Network and Sharing Center”, then click “Ethernet” (May have different names).

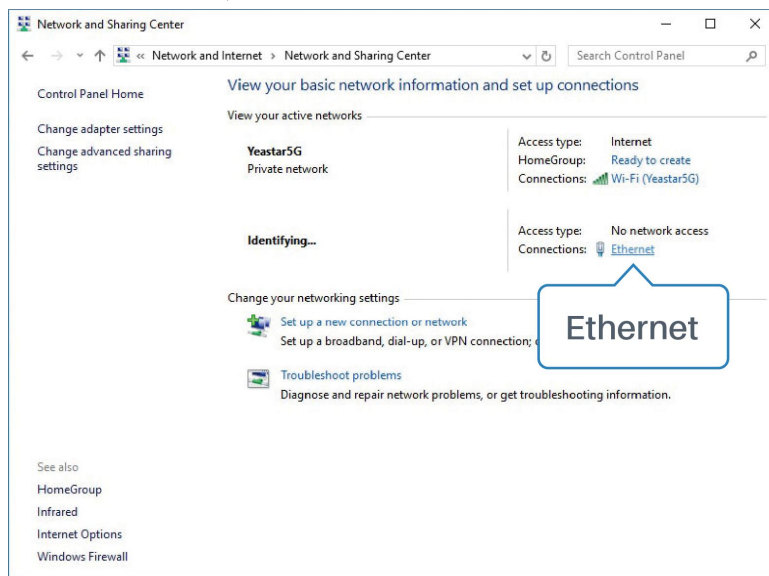

2. Go to “Properties” → “Internet Protocol Version 4(TCP/IPv4)”, select “Obtain an IP address automatically” or “Use the following IP address”, then assign a static IP manually within the same subnet of the device.

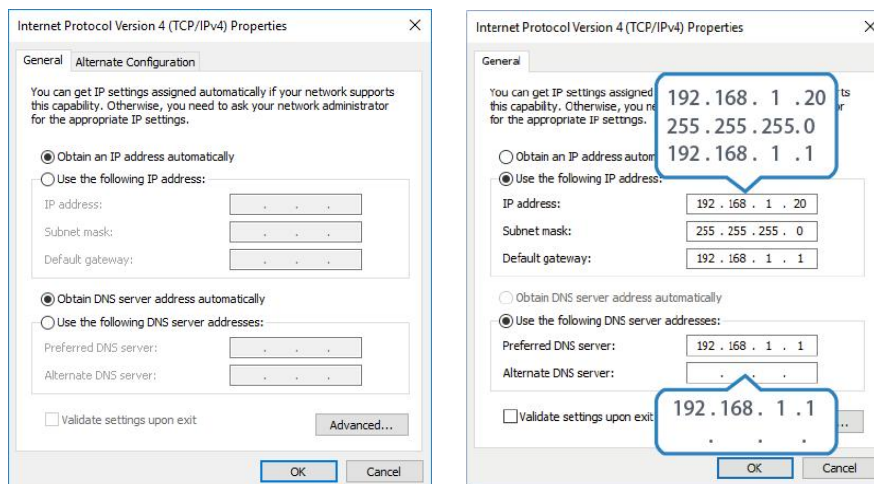

3. Open a Web browser on your PC (Chrome is recommended) and type in the IP address **192.168.1.1** to access the web GUI.

4. Enter the username and password, click “Login”.

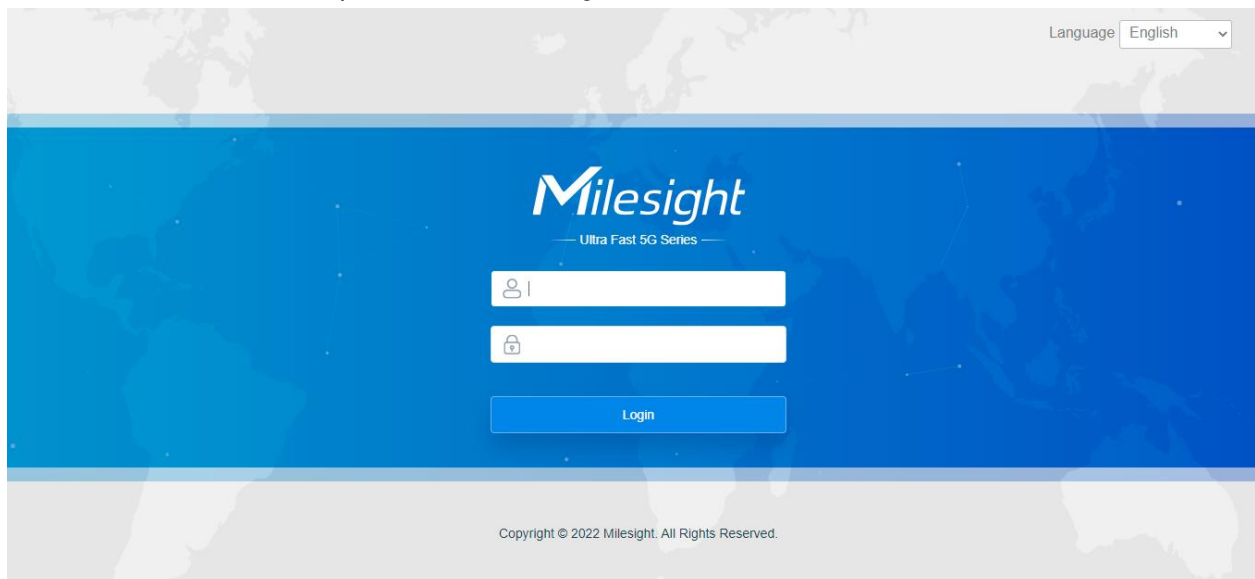

The login page features a blue header with the Milesight logo and the tagline "Ultra Fast 5G Series". A language dropdown menu is set to "English". The main content area contains a username input field with a person icon, a password input field with a lock icon, and a blue "Login" button. The footer includes the copyright notice: "Copyright © 2022 Milesight. All Rights Reserved."

! If you enter the username or password incorrectly more than 5 times, the login page will be locked for 10 minutes.

5. After logging in the web GUI, you can view system information and perform configuration of the device. It's suggested to go to “System” → “Administration” page to change the device password for security.

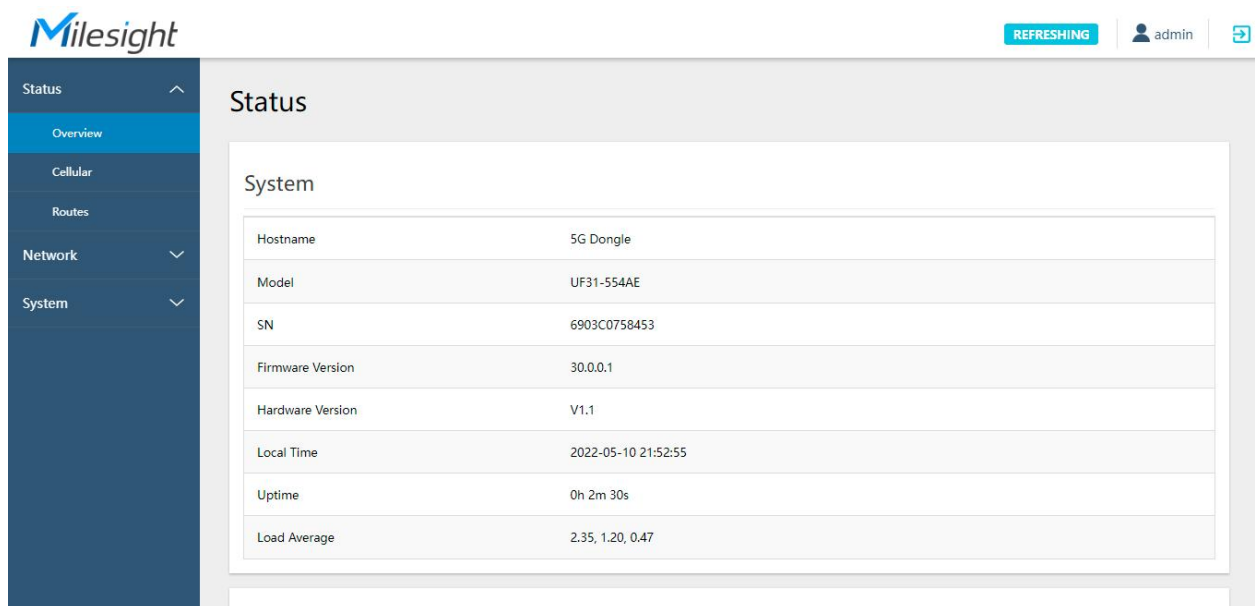

The web GUI shows the Milesight logo and a "REFRESHING" button. The user is logged in as "admin". The left sidebar contains a navigation menu with "Status" selected. The main content area displays the "Status" page, which includes a "System" section with the following information:

System	
Hostname	5G Dongle
Model	UF31-554AE
SN	6903C0758453
Firmware Version	30.0.0.1
Hardware Version	V1.1
Local Time	2022-05-10 21:52:55
Uptime	0h 2m 30s
Load Average	2.35, 1.20, 0.47

5. Web Configuration

5.1 Status

5.1.1 Overview

You can view the system information of the device on this page.

System	
Hostname	5G Dongle
Model	UF31-554AE
SN	6903C0758453
Firmware Version	30.0.0.1
Hardware Version	V1.1
Local Time	2022-05-10 21:53:21
Uptime	0h 2m 56s
Load Average	2.23, 1.27, 0.51

System	
Item	Description
Hostname	Show the hostname of device, it can be modified on System > System > General Settings .
Model	Show the model name of device.
SN	Show the serial number of device.
Firmware Version	Show the current firmware version of device.
Hardware Version	Show the current hardware version of device.
Local Time	Show the current system time of device.
Uptime	Show the time since device has been powered and running.
Load Average	Averages over progressively longer periods of time (1, 5 and 15 minute averages), lower numbers are better.

Memory	
Total Available	430.56 MB / 658.86 MB (65%)
Used	228.29 MB / 658.86 MB (35%)

Memory	
Item	Description
Total Available	Show the percentage of available RAM.
Used	Show the percentage of used RAM.

Active DHCP Leases

Hostname	IPv4-Address	MAC-Address	Leasetime remaining
DESKTOP-QL47997	192.168.1.155	5E:0A:2F:F8:B7:5B	8h 16m 7s

Active DHCPv6 Leases

Host	IPv6-Address	DUID	Leasetime remaining
<i>There are no active leases</i>			

Item	Description
Active DHCP Leases	
Hostname	Show the hostname of the connected device.
IPv4-Address	Show the IPv4 address of the connected device.
MAC-Address	Show the MAC address of the connected device.
Leasetime remaining	Show the time remaining for this lease.
Active DHCPv6 Leases	
Host	Show the hostname of the connected device.
IPv6-Address	Show the IPv6 address of the connected device.
DUID	Show the DHCPv6 unique Identifier of this device.
Leasetime remaining	Show the time remaining for this lease.

5.1.2 Cellular

You can view the cellular network status of device on this page.

Modem

Status	Ready
Module Model	FG360-EAU
Version	81102.7000.00.06.01.32
Signal Level	-
Register Status	Not registered
IMEI	868866050046064
IMSI	-
ICCID	-
ISP	-
Network Type	-
PLMN ID	-

LAC	-
Cell ID	-
CQI	-
DL Bandwidth	-
UL Bandwidth	-
SINR	-
PCI	-
RSRP	-
RSRQ	-
EARFCN	-

Modem Information	
Item	Description
Status	Show corresponding detection status of module and SIM card.
Module Model	Show the name of cellular module.
Version	Show the cellular module firmware version.
Signal Level	Show the cellular signal level.
Register Status	Show the registration status of SIM card.
IMEI	Show the IMEI of the module.
IMSI	Show IMSI of the SIM card.
ICCID	Show ICCID of the SIM card.
ISP	Show the network provider which the SIM card registers on.
Network Type	Show the connected network type, such as 5G NR, LTE, etc.
PLMN ID	Show the current PLMN ID, including MCC, MNC, LAC and Cell ID.
LAC	Show the location area code of the SIM card.
Cell ID	Show the Cell ID of the SIM card location.
CQI	Show the Channel Quality Indicator of the cellular network.
DL Bandwidth	Show the DL bandwidth of the cellular network.
UL Bandwidth	Show the UL bandwidth of the cellular network.
SINR	Show the Signal Interference + Noise Ratio of the cellular network.
PCI	Show the physical-layer cell identity of the cellular network.
RSRP	Show the Reference Signal Received Power of the cellular network.
RSRQ	Show the Reference Quality Received Power of the cellular network.
ECGI	Show the E-UTRAN Cell Global Identifier of the cellular network.
EARFCN	Show the E-UTRA Absolute Radio Frequency Channel Number.

Network

Status	Disconnected
IPv4 Address	-
IPv4 Gateway	-
IPv4 DNS	-
IPv6 Address	-
IPv6 Gateway	-
IPv6 DNS	-
Connection Duration	-

Network	
Item	Description
Status	Show the connection status of cellular network.
IPv4/IPv6 Address	Show the IPv4/IPv6 address and netmask of cellular network.
IPv4/IPv6 Gateway	Show the IPv4/IPv6 gateway and netmask of cellular network.
IPv4/IPv6 DNS	Show the DNS of cellular network.
Connection Duration	Show information on how long the cellular network has been connected.

Related Application

[Cellular Application](#)

5.1.3 Routes

You can check routing status on this page, including the routing table and ARP cache.

ARP

IPv4-Address	MAC-Address	Interface
192.168.1.155	16:E9:2C:9E:32:98	lan

Active [IPv4](#)-Routes

Network	Target	IPv4-Gateway	Metric	Table
lan	192.168.1.0/24	-	0	main

IPv6 Neighbours

IPv6-Address	MAC-Address	Interface
--------------	-------------	-----------

Active [IPv6](#)-Routes

Network	Target	Source	Metric	Table
lan	fd1a:3446:8a5b::/64	-	1024	main

Item	Description
ARP	
IPv4-Address	Show the IP address of ARP pool.
MAC-Address	Show the IP address's corresponding MAC address.
Interface	Show the binding interface of ARP.
Active IPv4-Routes	
Network	Show the outbound interface of the route.
Target	Show the IP address of destination host or destination network.
IPv4-Gateway	Show the IP address of the gateway.
Metric	Show the metric of the route.
Table	Show the property of the routing table, possible values are main, local, default, etc.
IPv6 Neighbours	
IPv6-Address	Show the IP address of the pool.
MAC-Address	Show the corresponding MAC address of the IP address.
Interface	Show the binding interface.
Active IPv6-Routes	
Network	Show the outbound interface of the route.
Target	Show the IP address of destination host or destination network.
Source	Show the source of the route.
Metric	Show the metric of the route.
Table	Show the type of the routing table, possible values are main, local, default, etc.

5.2 Network

5.2.1 Interfaces

This section describes the networking interfaces including cellular and LAN.

5.2.1.1 Cellular

Interfaces Global network options

Interfaces

Cellular

Type: Tunnel Interface
Device: mipc-wan
Connected: no
RX: 0 B (0 Pkts.)
TX: 0 B (0 Pkts.)

LAN

Uptime: 0h 13m 51s
MAC: 24:E1:24:F4:11:CC
RX: 679.87 KB (5416 Pkts.)
TX: 5.10 MB (4061 Pkts.)
IPv4: 192.168.1.1/24
IPv6: fd1a:3446:8a5b::1/60

RX: 0 B (0 Pkts.)
TX: 0 B (0 Pkts.)

RESTART EDIT

RESTART EDIT

Cellular	
Item	Description
Type	Show the connection method of this interface.
Device	Show the adapter used on this interface.
Connected	Show the connection status of this interface.
RX	Show the data volume and packets received in this interface.
TX	Show the data volume and packets transmitted from this interface.
RESTART	Click to restart this interface
EDIT	Click to edit general settings and ping detection of this interface.

Interfaces » Cellular

General Settings Ping Detection

Status  RX: 0 B (0 Pkts.)
TX: 0 B (0 Pkts.)

Protocol Type IPv4

APN

PIN Code *

Authentication Type NONE

Network Type Auto

Roaming

Emergency Reboot

DISMISS SAVE

General Settings	
Item	Description
RX	Show the data volume and packets received in this interface.
TX	Show the data volume and packets transmitted from this interface.
Protocol Type	Show the Internet protocol type to use for this interface. Selectable from "IPv4", "IPv6" and "IPv4/IPv6".
APN	Enter the Access Point Name for cellular dial-up connection provided by local ISP.
PIN Code	Enter a 4-8 characters PIN code to unlock the SIM.
Authentication Type	Select from "NONE", "PAP", "CHAP" and "PAP/CHAP".
Network Type	Select from "Auto", "5G Only", "4G Only" and "3G Only". Auto: connect to the network with the strongest signal automatically. 5G Only: connect to 5G network only. And so on.
Roaming	Enable or disable roaming.
Emergency Reboot	Enable to reboot the device if this link is unavailable.

Interfaces » Cellular

General Settings Ping Detection

Enable

IPv4 Primary Server 8.8.8.8

IPv4 Secondary Server 114.114.114.114

IPv6 Primary Server 2001:4860:4860::8888

IPv6 Secondary Server 2400:3200::1

Retry Interval 5 s

Timeouts 3 s

Max Ping Retries 3

DISMISS SAVE

Ping Detection	
Item	Description
Enable	If enabled, the device will periodically detect the connection status of the link.
IPv4 Primary Server	The device will send ICMP packet to the IPv4 address or hostname to determine whether the Internet connection is still available or not.
IPv4 Secondary Server	The device will try to ping the secondary server if primary server is not available.
IPv6 Primary Server	The device will send ICMP packet to the IPv6 address or hostname to determine whether the Internet connection is still available or not.
IPv6 Secondary Server	The device will try to ping the secondary server if primary server is not available.
Retry Interval	Set the ping retry interval. When ping failed, the device will ping again in every retry interval.
Timeout	The maximum amount of time the device will wait for a response to a ping request. If it does not receive a response for the amount of time defined in this field, the ping request will be considered to have failed.
Max Ping Retries	The retry times of the device sending ping request until determining that the connection has failed.

Related Application

[Cellular Application](#)

5.2.1.2 LAN

Interfaces Global network options

Interfaces

Cellular



RX: 0 B (0 Pkts.)
TX: 0 B (0 Pkts.)

RESTART EDIT

LAN



Uptime: 0h 17m 45s
MAC: 24:E1:24:F4:11:CC
RX: 761.83 KB (7053 Pkts.)
TX: 3.96 MB (3876 Pkts.)
IPv4: 192.168.1.1/24
IPv6: fd1a:3446:8a5b::1/60

RESTART EDIT

Type: Ethernet Adapter
Device: eth0
Connected: yes
MAC: 24:E1:24:F4:11:CC
RX: 0 B (0 Pkts.)
TX: 0 B (0 Pkts.)

SAVE & APPLY SAVE

LAN	
Item	Description
Type	Show the connection method of this interface.
Device	Show the adapter used on this interface.
Connected	Show the connection status of this interface.
MAC	Show the MAC address of connected device on this interface.
RX	Show the data volume and packets received in this interface.
TX	Show the data volume and packets transmitted from this interface.
RESTART	Click to restart this interface
EDIT	Click to edit general settings and ping detection of this interface.

Interfaces » LAN

General Settings **Advanced Settings** DHCP Server

Status  Uptime: 0h 22m 0s
 MAC: 24:E1:24:F4:11:CC
 RX: 825.98 KB (7553 Pkts.)
 TX: 4.57 MB (4412 Pkts.)
 IPv4: 192.168.1.1/24
 IPv6: fd1a:3446:8a5b::1/60

IPv4 address

IPv4 netmask

IPv6 assignment length

Assign a part of given length of every public IPv6-prefix to this interface

IPv6 assignment hint

Assign prefix parts using this hexadecimal subprefix ID for this interface.

DISMISS **SAVE**

General Settings

Item	Description
Uptime	Show the information about how long the device has been running.
MAC	Show the MAC address of LAN interface.
RX	Show the data volume and packets received in this interface.
TX	Show the data volume and packets transmitted from this interface.
IPv4	Show the IPv4 address of LAN interface.
IPv6	Show the IPv6 address of LAN interface.
IPv4 Address	Set the IPv4 address of LAN interface.
IPv4 netmask	Set the netmask for LAN interface.
IPv6 assignment length	Assign a part of given length of every public IPv6-prefix to this interface.
IPv6 assignment hint	Assign prefix parts using this hexadecimal sub-prefix ID for this interface.

Interfaces » LAN

General Settings **Advanced Settings** DHCP Server

Override MTU

DISMISS **SAVE**

Advanced Settings

Item	Description
Override MTU	Set the maximum transmission unit. Range: 68-1500.

General Settings Advanced Settings DHCP Server

General Setup IPv6 Settings Static Leases

Ignore interface

Disable DHCP for this interface.

Start 100

Lowest leased address as offset from the network address.

Limit 150

Maximum number of leased addresses.

IPv4 Lease time 12h

Expiry time of leased addresses, minimum is 2 minutes (2m).

IPv4-Netmask 255.255.255.0

Override the netmask sent to clients. Normally it is calculated from the subnet that is served.

DNS Server 192.168.1.1

DHCP Server-General Setup

Item	Description
Ignore interface	Enable to disable DHCP for this interface.
Start	Set the lowest leased address as offset from the network address.
Limit	Set the maximum number of leased addresses.
IPv4 Lease time	Set the expiry time of leased addresses, minimum is 2 minutes (2m).
IPv4-Netmask	Set to override the netmask sent to clients. Normally it is calculated from the subnet that is served.
DNS Server	Set the DNS server list for clients.

Interfaces » LAN

General Settings Advanced Settings DHCP Server

General Setup IPv6 Settings Static Leases

Enable

Router Advertisement-Service Server Mode

DHCPv6-Service Server Mode

DHCPv6-Mode stateless

Announced DNS servers

DISMISS SAVE

DHCP Server-IPv6 Settings

Item	Description
Enable	Choose to enable DHCPv6 server.
Router Advertisement-Service	Show the DHCPv6 gateway option.
DHCPv6-Service	Show the DHCPv6 service option.
DHCPv6-Mode	Show the DHCPv6 mode
Announced DNS Server	Set the DNS server list for clients.

Interfaces » LAN

General Settings Advanced Settings DHCP Server

General Setup IPv6 Settings Static Leases

Static leases are used to assign fixed IP addresses and symbolic hostnames to DHCP clients. They are also required for non-dynamic interface configurations where only hosts with a corresponding lease are served.
Use the *Add* Button to add a new lease entry. The *MAC-Address* identifies the host, the *IPv4-Address* specifies the fixed address to use, and the *Hostname* is assigned as a symbolic name to the requesting host. The optional *Lease time* can be used to set non-standard host-specific lease time, e.g. 12h, 3d or infinite.

Hostname	MAC-Address	IPv4-Address	IPv4 Lease time	DUID	IPv6-Suffix (hex)
This section contains no values yet					

ADD

DISMISS SAVE

DHCP Server-Static Leases	
Item	Description
Hostname	Show the hostname of static leases.
MAC-Address	Show the MAC address of the client.
IPv4-Address	Show the IPv4 address of the client.
IPv4 Lease time	Show the time remaining for the client.
DUID	Show the DHCP Unique Identifier of this device.
IPv6-Suffix (hex)	Show the IPv6 suffix of the client in hex.

5.2.1.3 Global network options

Interfaces Global network options

IPv6 ULA-Prefix

SAVE & APPLY SAVE

Global network options	
Item	Description
IPv6 ULA-Prefix	Show the IPv6 unique local address (ULA) prefix of this device.

5.2.2 Device Management

You can connect the device to the Milesight DeviceHub on this page so as to manage the device centrally and remotely. For more details, please refer to [DeviceHub User Guide](#).

Device Management

Status Disconnected

Server Address 192.168.45.45

Activation Method By Account name

Account name nicole@milesight.com

Password *****

CONNECT

Device Management	
Item	Description
Status	Show the connection status between the device and the DeviceHub.
Disconnected	Click this button to disconnect the device from the DeviceHub.
Server Address	IP address or domain of the device management server.
Activation Method	Select activation method to connect the device to the DeviceHub server, options are "By Authentication Code" and "By Account name".
Authentication Code	Fill in the authentication code generated from the DeviceHub.
Account Name	Fill in the registered DeviceHub account (email) and password.
Password	

5.2.3 Diagnostics

Network Utilities as troubleshooting tools includes IPv4/IPv6 ping, IPv4/IPv6 traceroute, nslookup the command-line tool.

Status

Network

Interfaces

Device Management

Diagnostics

Network Utilities

IPv4 PING

IPv4 TRACEROUTE

NSLOOKUP

Network Utilities	
Item	Description
IPv4 Ping	Click to ping outer network from the device in IPv4.
IPv6 Ping	Click to ping outer network from the device in IPv6.
IPv4 traceroute	Address of the destination host to be detected in IPv4.
IPv6 traceroute	Address of the destination host to be detected in IPv6.
Nslookup	Click to obtain the mapping between domain name and IP address, or other DNS records.

5.3 System

This section describes how to configure general settings, such as administration account, system time, system maintenance tools and management.

5.3.1 System

5.3.1.1 General Settings

System

Here you can configure the basic aspects of your device like its hostname or the timezone.

General Settings
Time Synchronization

Local Time 2022/05/11 12:24:12

SYNC WITH BROWSER
SYNC WITH NTP-SERVER

Hostname 5G Dongle

Timezone UTC ▼

SAVE & APPLY
SAVE

General Settings	
Item	Description
Local Time	Show the current system time.
Sync with Browser	Synchronize time with browser.
Sync with NTP-Server	Synchronize time with NTP Server.
Hostname	Define the device name, needs to start with a letter.
Timezone	Click the drop-down list to select the time zone you are in.

5.3.1.2 Time Synchronization

General Settings
Time Synchronization

Enable NTP client

Provide NTP server

NTP server candidates

pool.ntp.org	✖
cn.pool.ntp.org	✖
time.nist.gov	✖
	+

Time Synchronization	
Item	Description
Enable NTP client	Enable to synchronize time from an external NTP server.
Provide NTP server	Enable to provide NTP server for connected devices.
NTP server candidates	Enter NTP Server's IP address or domain name to synchronize time from, it can add 5 servers at most.

5.3.2 Administration

5.3.2.1 Router Password

You can change the administrator password for accessing the device.

Router Password SSH Access SSH-Keys

Router Password

Changes the administrator password for accessing the device

Password

Confirmation

[SAVE](#)

Router Password	
Item	Description
Password	Enter a new password.
Confirmation	Enter the new password again

5.3.2.2 SSH Access

UF31 adopts Dropbear to offer SSH network shell access and an integrated SCP server.

Router Password SSH Access SSH-Keys

SSH Access

Dropbear offers [SSH](#) network shell access and an integrated [SCP](#) server

Port

Local access

Remote access

SSH Access	
Item	Description
Port	Enter the port number for SSH service.
Local access	Enable to allow access from directly connected devices.
Remote access	Enable to allow access from remote devices.

5.3.2.3 SSH-Keys

Public keys allow for the passwordless SSH logins with a higher security compared to the use of plain passwords. In order to upload a new key to the device, paste an OpenSSH compatible public key line or drag a .pub file into the input field.

Router Password SSH Access **SSH-Keys**

SSH-Keys

Public keys allow for the passwordless SSH logins with a higher security compared to the use of plain passwords. In order to upload a new key to the device, paste an OpenSSH compatible public key line or drag a `.pub` file into the input field.

No public keys present yet.

Paste or drag SSH key file...

ADD KEY

SSH-Keys	
Item	Description
Add Key	Click to import the SSH key file. It only allows to import RSA or ECDSA keys.

5.3.3 Backup / Flash Firmware

This section describes how to create a complete backup of the system configurations to a file, reset to factory defaults, restore the config file to the device and upgrade the flash image via web. Generally, you don't need to do the firmware upgrade.

Note: any operation on web page is not allowed during firmware upgrade, otherwise the upgrade will be interrupted, or even the device will break down.

Flash operations

Actions

Click "Generate archive" to download a tar archive of the current configuration files.

Download backup [GENERATE ARCHIVE](#)

To restore configuration files, you can upload a previously generated backup archive here. To reset the firmware to its initial state, click "Perform reset"

Reset to defaults [PERFORM RESET](#)

Restore backup [UPLOAD ARCHIVE...](#)

Custom files (certificates, scripts) may remain on the system. To prevent this, perform a factory-reset first.

Upload a image here to replace the running firmware.

Image [FLASH IMAGE...](#)

Flash operations	
Item	Description
Generate Archive	Click to download a tar archive of the current configuration files.
Perform Reset	Click to reset the device to factory default.
Upload Archive...	To restore configuration files, you can upload a previously generated backup archive here. Custom files (certificates, scripts) may remain on the system. To prevent this, perform a factory-reset first.
Flash Image...	Upload an image here to replace the running firmware.

Related Configuration Example

[Firmware Upgrade](#)

[Restore Factory Defaults](#)

5.3.4 Reboot

This page allows to reboot the device immediately or regularly.

Reboot

Reboots the operating system of your device

REBOOT NOW

Schedule

Enable

Cycles Every Day ▼

Time --:-- 🕒

SAVE

Reboot	
Item	Description
Reboot Now	Reboot the device immediately.
Schedule	
Enable	Click to enable reboot schedule.
Cycles	Reboot the device at a scheduled frequency.
Time	Select the time to execute the schedule.

5.3.5 Log Control

The system log contains a record of informational, error and warning events that indicates how the system processes. By reviewing the data contained in the log, an administrator or user troubleshooting the system can identify the cause of a problem or whether the system processes are loading successfully. Remote log server is feasible, and the device will upload all system logs to remote log server such as Syslog Watcher.

5.3.5.1 General Settings

- Status ▼
- Network ▼
- System ▲
- System
- Administration
- Backup / Flash Firmware
- Reboot
- Log Control

Log Control

General Settings
Advanced Settings

External system log server 0.0.0.0

External system log server port 514

External system log server protocol UDP ▼

Cron Log Level Debug ▼

SAVE & APPLY
SAVE

General Settings	
Item	Description
External system log server	Fill in the remote system log server address (IP/domain name).

External system log server port	Fill in the remote system log server port.
External system log server protocol	Choose "UDP" or "TCP" from the drop-down list to transmit log file in corresponding protocol.
Cron Log Level	The list of severities follows the syslog protocol.

5.3.5.2 Advanced Settings

This section describes how to download log files and tcpdump log.

The screenshot shows the 'Advanced Settings' tab in a web interface. It contains two main sections: 'AP log' and 'Tcpdump log'. The 'AP log' section has a 'Start' button and a 'DOWNLOAD' button. The 'Tcpdump log' section has 'START', 'STOP', and 'DOWNLOAD' buttons.

Advanced Settings	
Item	Description
AP log	
Start	Click to start recording AP log.
Stop	Click to stop recording AP log.
Download	Click to download the last AP log recorded.
Tcpdump log	
Start	Click to start recording tcpdump log.
Stop	Click to stop recording tcpdump log.
Download	Click to download the last tcpdump log recorded.

5.3.6 Cellular Debugger

This tool allows to use AT commands to check cellular debug information. You can press the common commands on the top of black frame directly to execute or enter the AT command that you want to send to cellular modem.

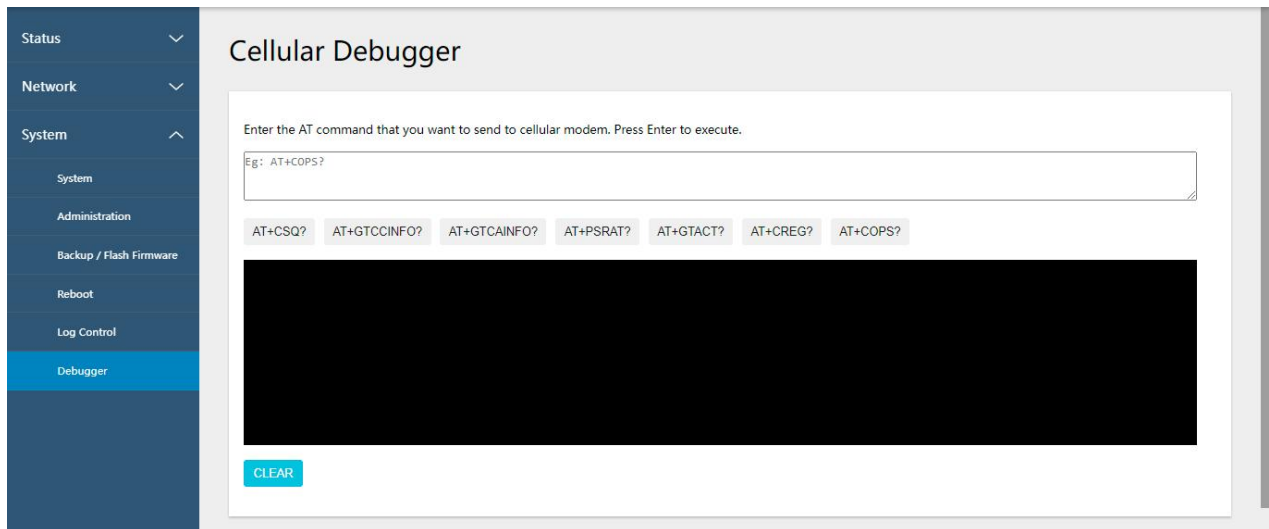
**Common command description:**

AT+CSQ?----Get cellular network signal

AT+GTCCINFO?----Get current cell information

AT+GTCAINFO?----Get CA information

AT+PSRAT?----Get network type

AT+GTACT?----Get RAT and bands

AT+CREG?----Get network registration status

AT+COPS?----Get operator and access technology info

6. Application Examples

6.1 Cellular Connection

1. Go to "Network" → "Interfaces" → "Cellular EDIT" to configure the cellular info.

Interfaces » Cellular

General Settings Ping Detection

Status **RX: 0 B (0 Pkts.)**
TX: 0 B (0 Pkts.)

Protocol Type IPv4

APN

PIN Code

Authentication Type NONE

Network Type Auto

Roaming

Emergency Reboot

DISMISS SAVE

Click "Save" for configuration to take effect.

2. Click "**Ping Detection**" to configure ICMP ping detection information. UF31 will send ICMP packages to check network connection regularly.

Interfaces » Cellular

General Settings Ping Detection

Enable

IPv4 Primary Server 8.8.8.8

IPv4 Secondary Server 114.114.114.114

IPv6 Primary Server 2001:4860:4860:8888

IPv6 Secondary Server 2400:3200::1

Retry Interval 5 s

Timeouts 3 s

Max Ping Retries 3

DISMISS SAVE

3. Go to "Status" → "Cellular" page to view the status of the cellular connection. If it shows 'Connected' and receives an IP address, the SIM has dialed up successfully.

Modem

Status	Ready
Module Model	FG360-EAU
Version	81102.7000.00.06.01.32
Signal Level	5asu (-103dBm)
Register Status	Registered(Home network)
IMEI	868866050046064
IMSI	460077592394358
ICCID	898600A51318F2056358
ISP	CHINAMOBILE
Network Type	4G
PLMN ID	46000
LAC	59E7
Cell ID	36B67A9
CQI	-
DL Bandwidth	20MHz
UL Bandwidth	20MHz
SINR	8dB
PCI	91
RSRP	-116dBm
RSRQ	-5.5dB
EARFCN	9FE8

Network

Status	Connected
IPv4 Address	10.141.33.235/29
IPv4 Gateway	10.141.33.236
IPv4 DNS	211.143.147.120
IPv6 Address	-
IPv6 Gateway	-
IPv6 DNS	-
Connection Duration	0days, 00:01:08

4. Go to "Network" → "Diagnostics" page to ping a valid address or domain to check network connection. You can also open a browser on PC, type any available web address into address bar

and see if it is able to visit Internet via the UF31 device.

Related Topic

[Cellular Settings](#)

[Cellular Status](#)

6.2 Firmware Upgrade

It is suggested that you contact Milesight technical support first before you upgrade device. After getting image file please refer to the following steps to complete the upgrade.

1. Go to "System" → "Backup/Flash Firmware" page, click "FLASH IMAGE...".

2. Browse the correct firmware file from the PC, click "UPLOAD" and the device will check if the firmware file is correct. If it's correct, the firmware will be imported to the device.

3. After upload, click "CONTINUE" to upgrade the device. Do not perform any operation or disconnect the power during the upgrade.

Flash image?

The flash image was uploaded. Below is the checksum and file size listed, compare them with the original file to ensure data integrity.
Click "Proceed" below to start the flash procedure.

- Size: 69.45 MB
- MD5: 642379c8508ebd793830b03e8ac90ca5
- SHA256: f2ba7b40562505b3e2c9708390e6ea9ab9546c93ff07b33aa450aa5040373135

KEEP SETTINGS AND RETAIN THE CURRENT CONFIGURATION

CANCEL CONTINUE

Flashing...

The system is flashing now.
DO NOT POWER OFF THE DEVICE!
Wait a few minutes until you try to reconnect. It might be necessary to renew the address of your computer to reach the device again, depending on your settings.

Related Topic

[Backup / Flash Firmware](#)

6.3 Restore Factory Defaults

Method 1:

Go to "System" → "Backup/Flash Firmware" page, click "PERFORM RESET" button, you will be asked to confirm if you'd like to reset it to factory defaults. Then click "OK" button.

Status

Network

System

System

Administration

Backup / Flash Firmware

Reboot

Log Control

Debugger

Flash operations

Actions Configuration

Click "Generate archive" to download a tar archive of the current configuration files.

Download backup **GENERATE ARCHIVE**

To restore configuration files, you can upload a previously generated backup archive here. To reset the firmware to its initial state, click "Perform reset" (only possible with squashfs images).

Reset to defaults **PERFORM RESET**

Restore backup **UPLOAD ARCHIVE...**

Custom files (certificates, scripts) may remain on the system. To prevent this, perform a factory-reset first.

Upload a sysupgrade-compatible image here to replace the running firmware.

Image **FLASH IMAGE...**

192.168.1.1 says

This operation will make the device lose all configurations, you determine that the device is to be reset to the factory settings?

OK Cancel

Then UF31 will reboot and restore to factory settings immediately.

Erasing...

The system is erasing the configuration partition now and will reboot itself when finished.

Please wait till the STATUS LED shines in green, which means the device has already been reset to factory defaults successfully.

Related Topic

[Backup / Flash Firmware](#)

Method 2:

Release the metal case and find the reset button on the mainboard, press and hold the reset button for more than 5 seconds until LED blinks.

[END]