



UniFi[®] XG SERVER

10G Rack-Mountable UniFi Application Server

Model: UAS-XG

Dual 3.5" Hard Drive Bays

Dual 10G Ethernet Ports

Pre-Installed UniFi[®] and UniFi Video[®] Software



UniFi® XG SERVER

Overview

The UniFi Application Server, model UAS-XG, is an Ubuntu-based server capable of securely running all of your business applications. It integrates UniFi and UniFi Video software for centralized management of your UniFi devices.

The UniFi Application Server features a fast 120 GB SSD for the OS and applications, as well as an 8 TB mechanical drive for bulk storage of video recordings and other data. A power-optimized Intel Xeon-D processor with 16 GB DDR4 memory provides reliable performance.

Dual 10G Ethernet ports ensure high-bandwidth connectivity for your most demanding server applications.

Pre-Installed Software The UniFi and UniFi Video Controller software applications are both pre-installed on the UniFi Server for immediate deployment.

Initial Setup via Bluetooth Use the UniFi Mobile app to configure the UniFi Application Server. The username and password you configure in the UniFi Mobile app will be used for the UniFi and UniFi Video software.

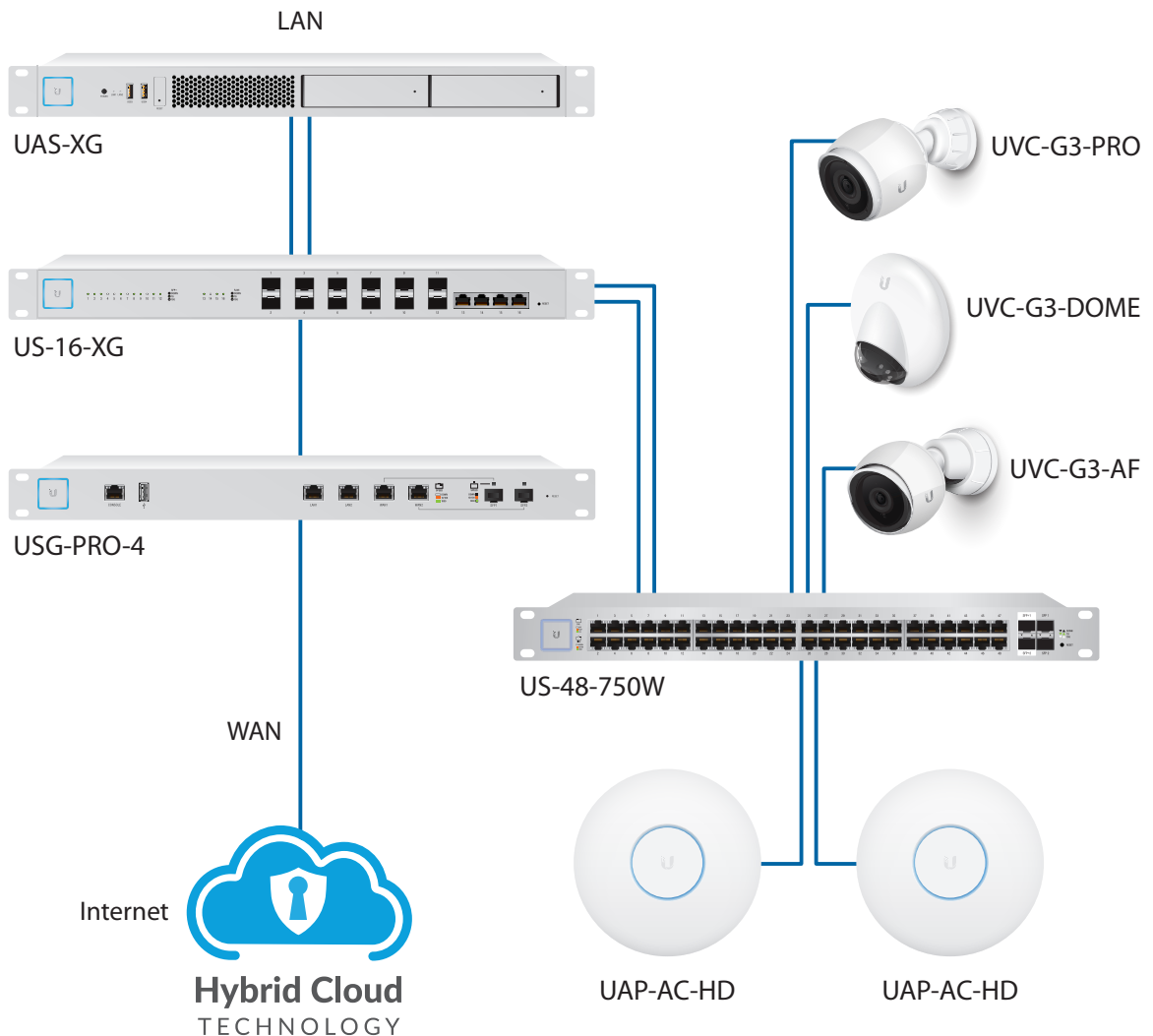
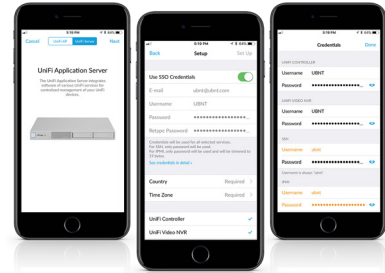



UniFi is a scalable networking system ideal for low-latency deployments requiring high uptime performance.

- Seamless integration of UniFi devices
- Centralized management and monitoring of multiple sites across remote locations
- Mobile app (iOS/Android) for quick and easy access



Dashboard

UniFi provides a visual representation of your network's status and delivers basic information about each segment.

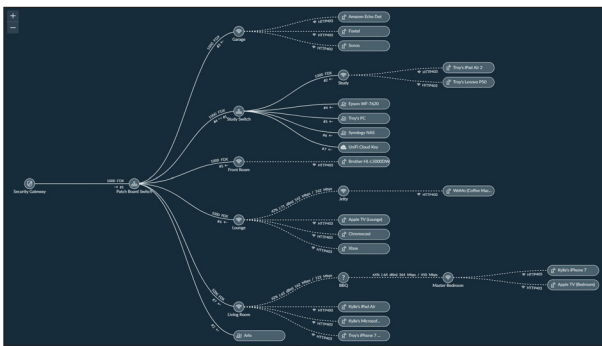

Topology

The topology tree shows UniFi wired/wireless network devices and client devices.

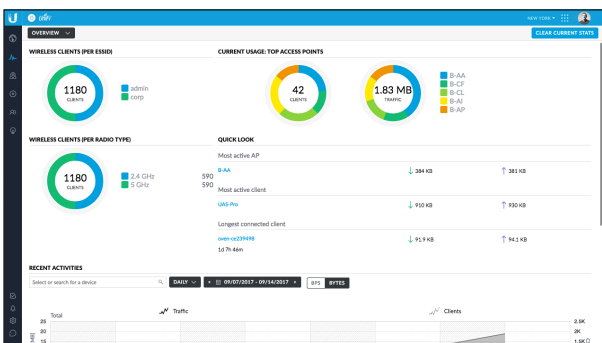

Statistics

UniFi offers statistics and graphs to describe the clients and network traffic of your managed UniFi network.



UniFi Video is a flexible, integrated IP video management and surveillance system using UniFi Video Cameras.

- Live feeds in a single or multi-camera format
- Motion detection and security alerts
- Detailed statistical reporting and advanced analytics
- Mobile app (iOS/Android) for control and live streaming

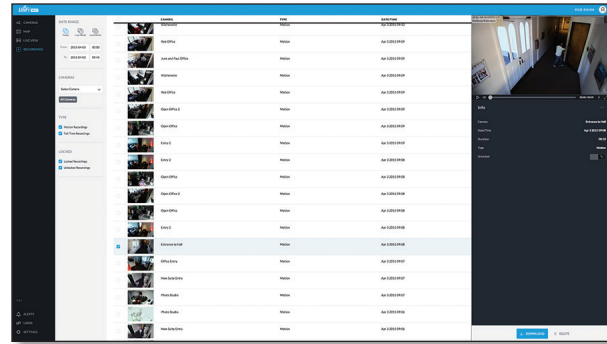

Event Recordings

UniFi Video software provides a variety of options and settings to customize what your cameras record.

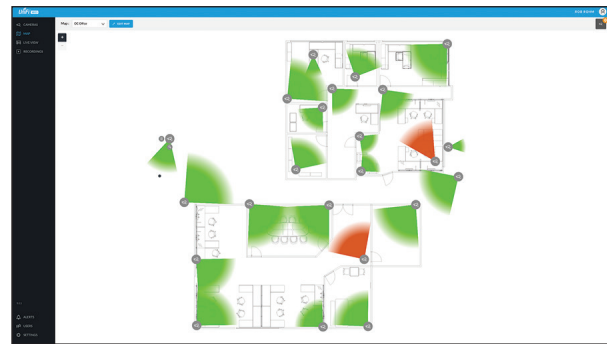

Maps

Upload a map of your location(s) or use Google Maps to represent the areas where your cameras are located.

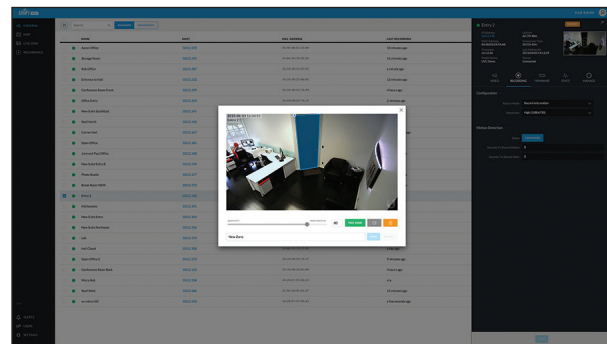

Analytic Capabilities

Customize your own motion detection zones. You can place several zones and set their alarm sensitivity levels.

Hardware Overview

Featuring dual 10G Ethernet for high throughput and a powerful Intel Xeon-D processor, the UniFi Application Server efficiently scales to serve large UniFi and UniFi Video installations.

The compact 1U form factor and pre-installed UniFi and UniFi Video software applications enable rapid deployment and plug-and-play integration.

Storage and Memory

- (2) 3.5" Hard Drive Bays
- (1) 8 TB Pre-Installed Hard Drive
- 120 GB Internal SSD
- UniFi and UniFi Video Software (Pre-Installed)
- 16 GB DDR4

Connectivity

- (2) 10G Ethernet Ports
- (2) USB 3.0 Ports (Rear)
- (2) USB 2.0 Ports (Front)
- Bluetooth for Initial Setup
- (1) 1G IPMI Ethernet Port
- (1) VGA Port

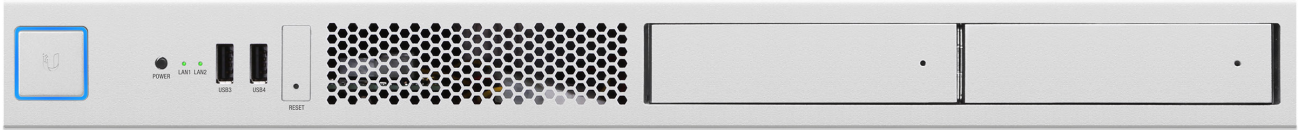

UAS-XG Front Panel



UAS-XG Back Panel



Attaching Rack-Mount Brackets to the UAS-XG

Specifications

UAS-XG	
Dimensions	442.4 x 43.7 x 305.5 mm (17.42 x 1.72 x 12.03")
Weight	6.5 kg (14.33 lb)
With Mount Brackets	6.6 kg (14.55 lb)
Power Consumption	150W Maximum (60W Typical)
Power Method	100-240VAC/50-60 Hz, Universal Input
Power Supply	100-240VAC, 2 to 4A, 50 to 60 Hz
Supported Voltage Range	100-240VAC
LEDs	
System	Bootup/Reset/Locate
Data Ports	Link/Activity
HDD Bays	Activity/Error
Processor	Intel Xeon D-1521
System Memory	16 GB DDR4
On-Board Flash Storage	M.2 SSD 120 GB
Hard Drive Capacity	(1) 8 TB HDD (Pre-Installed)
Operating Temperature	0 to 40° C (32 to 104° F)
Operating Humidity	5 to 90% Noncondensing
Rack Mount	1U High, 12" Depth (Rack-Mount Hardware Included)
Interfaces	
Networking Interfaces	(2) 1/10 Gbps RJ45 Ethernet Ports
IPMI Interface	(1) 1 Gbps RJ45 Ethernet Port
VGA Interface	(1) VGA Port
USB	(2) USB 3.0 Ports (Back Panel) (2) USB 2.0 Ports (Front Panel)
Bluetooth Low Energy	Bluetooth 4.0
Certifications	CE, FCC, IC



Specifications are subject to change. Ubiquiti products are sold with a limited warranty described at: www.ubnt.com/support/warranty
 ©2017-2019 Ubiquiti Networks, Inc. All rights reserved. Ubiquiti, Ubiquiti Networks, the Ubiquiti U logo, the Ubiquiti beam logo, UniFi, and UniFi Video are trademarks or registered trademarks of Ubiquiti Networks, Inc. in the United States and in other countries. Apple and the Apple logo are trademarks of Apple Inc., registered in the U.S. and other countries. App Store is a service mark of Apple Inc., registered in the U.S. and other countries. Google, Google Play, the Google Play logo and other marks are trademarks of Google LLC. All other trademarks are the property of their respective owners.